

YDS-M3MA-AR1335 V2.0

13MP OnSemi AR1335 PLCC MIPI-Schnittstelle Autofokus Kameramodul

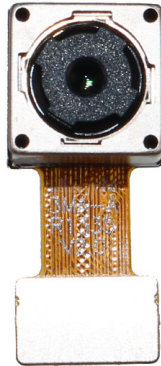

Vorderansicht

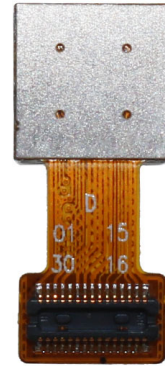

Rückansicht

Spezifikationen

Kameramodul Nr.	YDS-M3MA-AR1335 V2.0
Auflösung	13MP
Bildsensor	AR1335 PLCC
Sensorart	1/3.2"
Pixel Größe	1.1 um x 1.1 um
EFL	3.81 mm
F.NO	2.20
Pixel	4208 x 3120
Betrachtungswinkel	74.4°(DFOV) 62.7°(HFOV) 48.7°(VFOV)
Linsenabmessungen	8.50 x 8.50 x 5.60 mm
Modulgröße	19.57 x 8.50 mm
Modultyp	Autofokus
Schnittstelle	MIPI
Autofokus-VCM-Treiber-IC	FP5510
Linsenmodell	YDS-LENS-50013A1
Linsentyp	650 nm IR-Schnitt
Betriebstemperatur	-30°C to +70°C
Gegenstecker	DF30FC-30DS-0.4V

YDS-M3MA-AR1335 V2.0

13MP OnSemi AR1335 PLCC MIPI-Schnittstelle Autofokus Kameramodul



Ansicht von oben



Seitenansicht

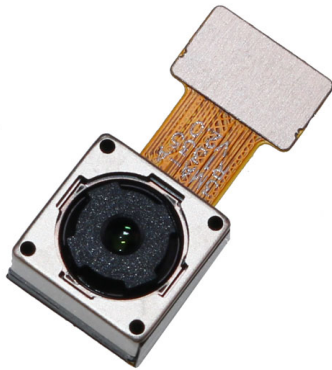

Untersicht

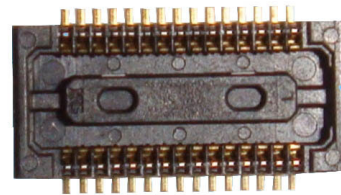

Gegenstecker

ROHS

PIN	SIGNAL
1	AVDD 2.8V
2	NC
3	DVDD 1.2V
4	DOVDD 1.8V
5	NC
6	AGND
7	AVDD 2.8V
8	DGND
9	SDA
10	SCL
11	RESET
12	NC
13	GND
14	MCLK
15	GND
16	MDP3
17	MDN3
18	GND
19	MDP2
20	MDN2
21	GND
22	MDP1
23	MDN1
24	GND
25	MCP
26	MCN
27	GND
28	MDP0
29	MDN0
30	GND

Version	Information	Date
V1.0	First Version	10-18-2019
V2.0	Change PIN signal and connector	5-8-2020

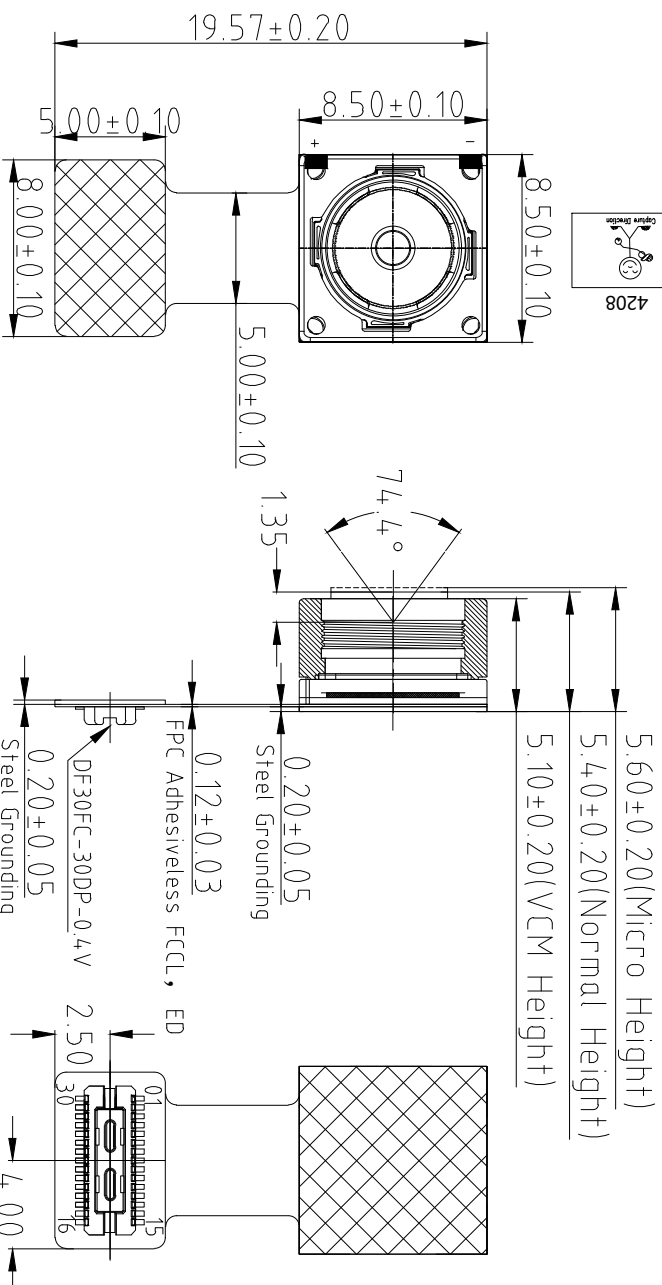
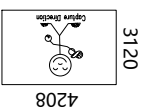

TOP VIEW

SIDE VIEW

BOTTOM VIEW

NOTE:

1.The device slave address:0x6C(w);0x6D(r)

Parameter:

1、Sensor specification:

Image Sensor: AR1335_PLCC
 Pixel: 1.1umx1.1um
 Lens Type: 1/3.2
 Important Voltage Description: DVDD1.2V (external power supply);

2、Lens specification:

FOV: 74.4°(D);62.7°(H);48.7°(V);
 F/N0: 2.2
 TV distortion: <1.5%
 Focal length: 3.81mm
 Composition: 5P+IR FILTER
 IR Cut Coating: 650nm \pm 10nm@50%

A

B

C

D

E

3

3

2

2

1

1

Product Overview

AR1335: 13 MP 1/3" CMOS Image Sensor

For complete documentation, see the data sheet.

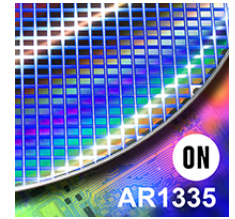

The AR1335 is a 1/3.2-inch CMOS active-pixel digital image sensor with a pixel array of 4208H x 3120V. The AR1335 digital image sensor, features breakthrough 1.1 μm pixel technology that delivers superior low-light image quality through leading sensitivity, quantum efficiency and linear full well. This allows image quality that rivals digital still cameras. With a sensor architecture focused on low power and a high Chief Ray Angle (CRA) for low Z-heights, the AR1335 is ideal for smartphone and other mobile device applications. It incorporates sophisticated on-chip camera functions such as windowing, mirroring, column and row skip modes, and snapshot mode. It is programmable through a simple two-wire serial interface. The AR1335 sensor can generate full resolution image at up to 30 frames per second (fps) and supports advanced video modes including 4K 30fps, 1080P 60fps and 720P 120fps.

Features

- 13MP CMOS sensor with advanced 1.1 μm pixel BSI technology
 - Data interfaces: 2,3 and 4 lane MIPI
 - Bit-depth compression available for MIPI: 10-8 and 10-6 to lower bandwidth
 - 3D synchronization controls to enable stereo video capture
 - 6.8 kbits one time programmable memory (OTPM)
 - Programmable controls: gain, horizontal and vertical blanking, auto black level offset correction, frame size/rate, exposure, left-right and top-bottom image reversal, window size, and panning
 - Two on-die phase-locked loop (PLL) oscillators for super low noise performance
 - On-chip temperature sensor
 - Bayer pattern horizontal down-size scaler
 - Simple two-wire fast-mode+ serial interface
- For more features, see the data sheet

Applications

- Mobile
- 4K video capture
- High resolution still capture

End Products

- Smart Phone
- Digital Still Camera
- PC Camera
- Consumer devices

Part Electrical Specifications

Product	Compliance	Status	Type	Megapixels	Frame Rate (fps)	Optical Format	Shutter Type	Pixel Size (μm)	Output Interface	Color	Package Type
AR1335CSSC11SMD20	Pb-free Halide free	Active	CMOS	13	30	1/3.2 inch	Electronic Rolling	1.1 x 1.1	MIPI	RGB	
AR1335CSSC11SMKA0-CP	Pb-free Halide free	Active	CMOS	13	30	1/3.2 inch	Electronic Rolling	1.1 x 1.1	MIPI	RGB	ODCSP-63
AR1335CSSC11SMKA0-CR	Pb-free Halide free	Active	CMOS	13	30	1/3.2 inch	Electronic Rolling	1.1 x 1.1	MIPI	RGB	ODCSP-63
AR1335CSSC32SMD20	Pb-free Halide free	Active	CMOS	13	30	1/3.2 inch	Electronic Rolling	1.1 x 1.1	MIPI	RGB	
AR1335CSSM11SMD20	Pb-free Halide free	Active	CMOS	13	30	1/3.2 inch	Electronic Rolling	1.1 x 1.1	MIPI	RGB	
AR1335CSSM32SMD20	Pb-free Halide free	Active	CMOS	13	30	1/3.2 inch	Electronic Rolling	1.1 x 1.1	MIPI	RGB	

Application Diagram

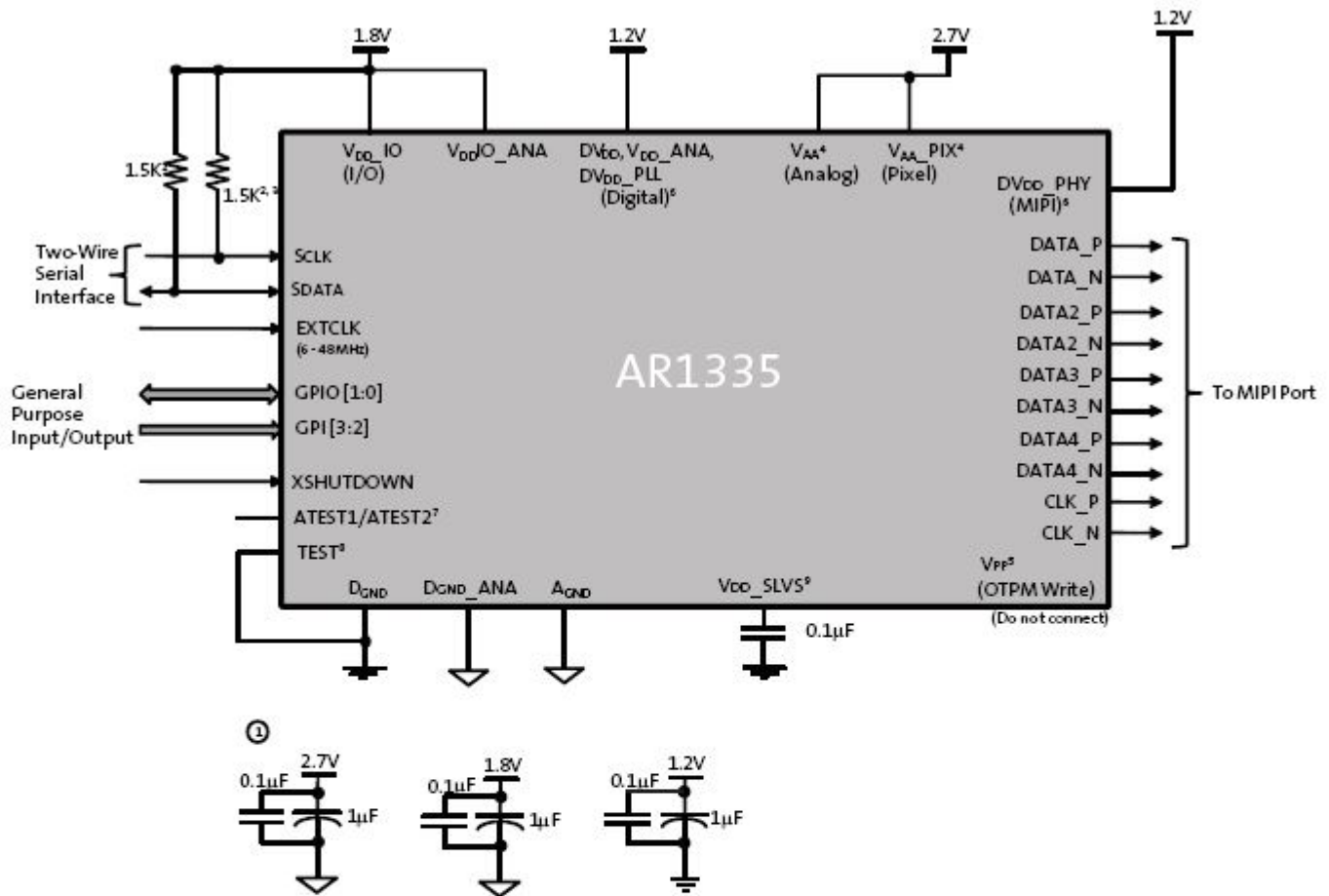

For connectivity above:

- Notes:
- All power supplies should be adequately decoupled; recommended cap values are:
 - 2.7V: 1.0 μ F and 0.1 μ F
 - 1.2V: 1.0 μ F and 0.1 μ F
 - 1.8V: 1.0 μ F and 0.1 μ F
 - Resistor value 1.5k Ω is recommended, but may be greater for slower two-wire speed.
 - This pull-up resistor is not required if the controller drives a valid logic level on SCLK at all times.
 - V_{AA} and V_{AA_PIX} must be tied together.
 - Internal charge pump is used for OTPM programming.
 - Digital and MIPI supply can be tied together.
 - ATEST1/AATEST2 must be left floating.
 - TEST pin must be tied to DGND.
 - V_{DD_SLVS} must be connected to DGND through a bypass cap (0.1 μ F).

For more information please contact your local sales support at www.onsemi.com.

Created on: 9/30/2017



1/3.2-Inch 13 Mp CMOS Digital Image Sensor

AR1335 Datasheet, Rev. A

For the latest datasheet, please visit: www.aptna.com

Features

- 13 Mp CMOS sensor with advanced 1.1 μm pixel BSI technology
- Data interfaces: two-, three-, and four-lane serial mobile industry processor interface (MIPI)
- Bit-depth compression available for MIPI Interface: 10-8 and 10-6 to enable lower bandwidth receivers for full frame rate applications
- 3D synchronization controls to enable stereo video capture
- 6.8 kbits one-time programmable memory (OTPM) for storing shading correction coefficients and module information
- Programmable controls: gain, horizontal and vertical blanking, auto black level offset correction, frame size/rate, exposure, left-right and top-bottom image reversal, window size, and panning
- Two on-die phase-locked loop (PLL) oscillators for super low noise performance
- On-chip temperature sensor
- Bayer pattern horizontal down-size scaler
- Simple two-wire fast-mode+ serial interface
- Low dark current
- Interlaced multi-exposure readout enabling High Dynamic Range (HDR) still and video applications
- On-chip lens shading correction
- Support for external mechanical shutter
- Support for external LED or Xenon Flash
- Extended Flash duration up to start of frame readout

Applications

- Cellular phones
- Digital still cameras
- PC cameras
- PDAs

Table 1: Key Performance Parameters

Parameter	Value	
Optical format	1/3.2 -inch 13 Mp (4:3)	
Active pixels	4208H x 3120V	
Pixel size	1.1 μm Back Side Illuminated (BSI)	
Chief ray angle (CRA)	32°	
Die size	6.3 mm x 5.7 mm	
Input clock frequency	6 - 48 MHz	
Interface	4-lane MIPI (2- and 3-lane supported); Max data rate: 1.2Gbps/lane	
Subsampling modes (column and row)	skip2 bin2 skip3 bin3 skip4 bin4 skip2bin2	
ADC resolution	10 bits, on-die	
Analog gain	1x – 7.75x	
Digital gain	Up to 7.98x	
Scaler	Adjustable scaling up to 8x	
Temperature sensor	10-bit, controlled by two-wire serial I/F	
Compression	DPCM: 10-8-10, 10-6-10	
3D support	Frame rate and exposure synchronization	
Supply voltage	VAA, VAA_PIX	2.6 - 2.9 V (2.7 V nominal)
	VDD_IO, VDDIO_ANA	1.7 - 1.9 V (1.8 V nominal)
	VDD, VDD_ANA, VDD_PLL, VDD_PHY	1.14 - 1.3 V (1.2 V nominal)
Power consumption	270 mW at 60°C (TYP) at 13 Mp 30 fps	
Responsivity	4700 e ⁻ /lux-sec	
SNRMAX	37 dB	
Dynamic Range	69 dB	
Operating Temperature Range (at junction) - Tj	-30°C to +70°C	

**Table 2: Mode of Operation and Power**

Mode	Resolution	Readout Configuration	HFOV	FPS	Power Consumption [mW]
4:3 Snapshot Mode					
13 M full resolution	4208x3120	13M full mode	100%	30	270
13 M full resolution	4208x3120	13M full mode	100%	24	250
VGA	640 x 480	Crop+Subsampling+Scaling	61%	120	190
QVGA	320 x 240	Crop+Subsampling+Scaling	30%	240	165
16:9 Video Mode 30 FPS					
4K UHD	3840 x 2160	Cropping	91%	30	230
4K Cinema	4096 x 2160	Cropping	97%	30	235
1080p	1920 x 1080	Crop+Subsampling+Scaling	91%	30	160
1080p LP	1920 x 1080	Crop+Subsampling+Scaling	91%	30	135
720p	1280 x 720	Crop+Subsampling+Scaling	91%	30	140
16:9 Video Mode 60 FPS					
1080p	1920 x 1080	Crop+Subsampling+Scaling	91%	60	210
1080p LP	1920 x 1080	Crop+Subsampling+Scaling	91%	60	180
720p	1280 x 720	Crop+Subsampling+Scaling	91%	60	175
3M 30 FPS					
3M	2000 x 1500	Crop+Subsampling+Scaling	95%	30	195
3M LP	2000 x 1500	Crop+Subsampling+Scaling	95%	30	170
16:9 Video Mode 120 FPS					
720p	1280 x 720	Crop+Subsampling+Scaling	91%	120	260

Ordering Information

Table 3: Available Part Numbers

Part Number	Description
AR1335C5SC32SMD20	Bare die

10-Bit DAC 120mA VCM Driver with I²C Interface

Description

The FP5510 is a single 10-bit DAC with 120mA output current voice coil motor (VCM) driver, with an I²C-compatible serial interface that operates at clock rates up to 400kHz. Its supply operates from 2.3V to 3.6V.

The FP5510 incorporates with a power-on reset circuit, power-down function. Power-on reset circuit ensure when supply power up, DAC output is to 0V until valid write bit value takes place. In power down mode, the supply current is about 1µA.

The FP5510 is designed for auto focus operation includes digital camera module, optical zoom camera phones and lens auto focus. The I²C address of FP5510 is 0x18h.

The FP5510 with WLCSP package which it is suitable for reduced-space mounting in mobile phone and other portable applications.

Pin Assignments

6-Ball WLCSP

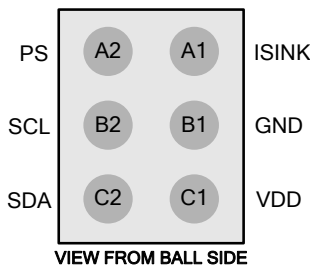

Figure 1. Pin Assignment of FP5510

Features

- Power Supply Voltage Rang: 2.3V to 3.6V
- VCM Driver for Auto-Focus
- 10-Bit Resolution Current Sinking of 120mA for VCM
- 2-Wire I²C Interface (1.8V Interface Compatible)
- Internal 4 Slope Control Mechanism
 1. Enhance Slope Control Mode
 2. One Step Mode
 3. Linear Slope Mode
 4. Two Step Slope Mode
- Power-Save Mode Current < 1µA
- Power On Reset (POR)
- Small Size: 0.7mm×1.1mm (6-Balls WLCSP)

Applications

- Digital Camera Module
- Cell Phone
- Lens Cover
- Web Camera

Ordering Information

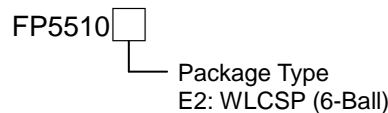

WLCSP-6 (0.7mm×1.1mm) Marking

Part Number	Product Code
FP5510E2	2

YDS-LENS-50013A1

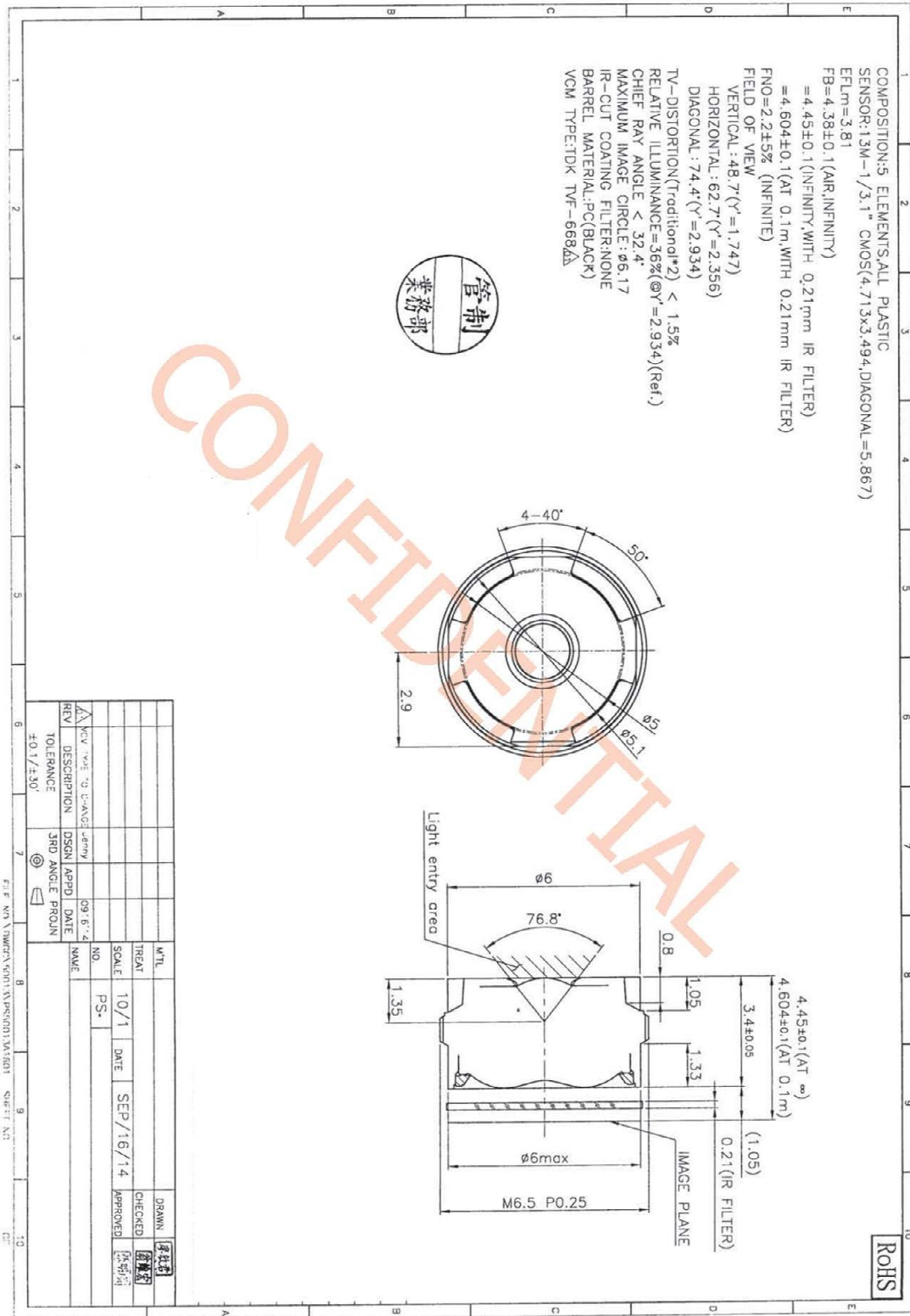

0.4 mm Pitch, 0.9 mm Height, Board-to-Board / Board-to-FPC Connectors

DF30 Series

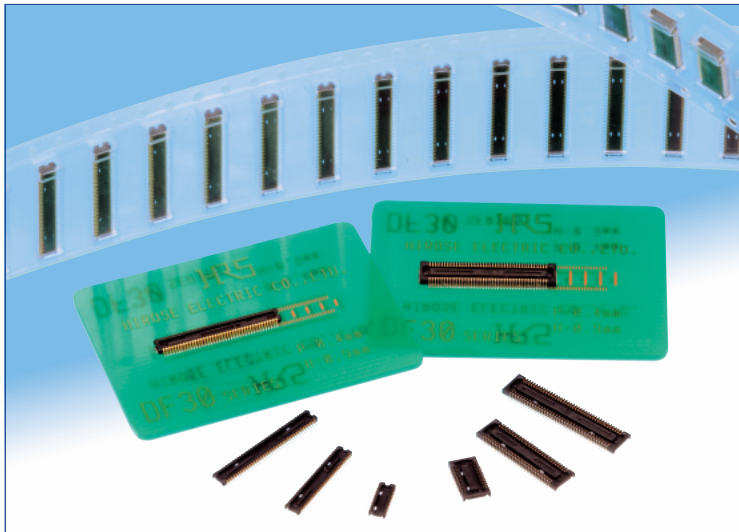

Extremely small size

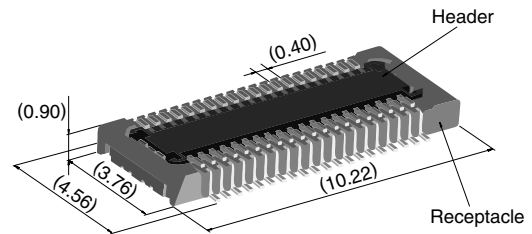

40 positions shown

Overview

Continuous miniaturization and increased component density on PCB created demand for extremely low profile connectors. This series is addition of a new extremely low profile connectors to Hirose's wide range of high reliability board-to-board/board-to-FPC connection solutions.

Features

1. Contact reliability

Concentration of the contact's normal forces at the single point assures good contact wipe and electrical reliability, while confirming the fully mated condition with a definite tactile click.

2. Self alignment

Recognizing the difficulties of mating extremely small connectors in limited spaces the connectors will self align in horizontal axis within 0.3 mm.

3. Automatic board placement

Packaged on tape-and-reel the plug and headers have sufficiently large flat areas to allow pick-up with vacuum nozzles of automatic placement equipment.

4. Variety of contact positions and styles

Available in standard contact positions of: 20, 22, 24, 30, 34, 40, 50, 60, 70 and 80 with and without metal fittings. Addition of metal fittings does not affect external dimensions of the connectors.

Smaller contact positions are also available.

5. Support for continuity test connector

Connectors which have increased insertion and removal durability are available for continuity tests. Contact your Hirose sales representative for details.

Applications

Cellular phones, PDA's, mobile computers, digital cameras, digital video cameras, and other devices demanding high reliability connections in extremely limited spaces.

Low profile

Increased mated retention

High contact reliability

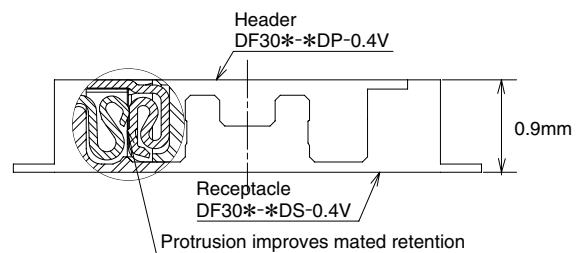

Self alignment

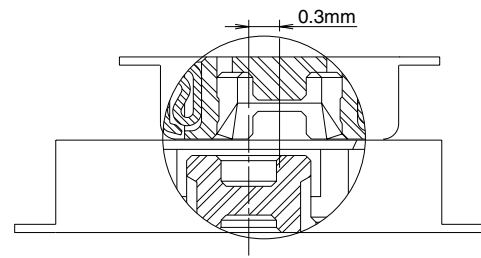

Product Specifications

Rating	Rated current 0.3A Rated voltage 30V AC	Operating temperature range : -35°C to 85°C (Note 1) Operating humidity range : Relative humidity 20% to 80%	Storage temperature range -10°C to 60°C (Note 2) Storage humidity range Relative humidity 40% to 70% (Note 2)
--------	--	---	--

Item	Specification	Conditions
1. Insulation resistance	50 MΩ min.	100V DC
2. Withstanding voltage	No flashover or insulation breakdown.	100V AC / one minute
3. Contact resistance	100 mΩ max.	100 mA
4. Vibration	No electrical discontinuity of 1 μs or more	Frequency: 10 to 55 Hz, single amplitude of 0.75mm, 2 hours, 3 axis
5. Humidity	Contact resistance: 100 mΩ max. Insulation resistance: 25 MΩ min.	96 hours at temperature of 40°C±2°C and RH of 90% to 95%
6. Temperature cycle	Contact resistance: 100 mΩ max. Insulation resistance: 50 MΩ min.	Temperature: -55°C→+5°C to +35°C→+85°C→+5°C to +35°C Duration: 30→10→30→10(Minutes) 5 cycles
7. Durability (insertions/withdrawals)	Contact resistance: 100 mΩ max.	50 cycles(Connector for conductivity tests: 500 cycles)
8. Resistance to soldering heat	No deformation of components affecting performance.	Reflow: At the recommended temperature profile Manual soldering: 300°C for 3 seconds

Note 1: Includes temperature rise caused by current flow.

Note 2: The term "storage" refers to products stored for long period of time prior to mounting and use. Operating temperature range and humidity range covers non-conducting condition of installed connectors in storage, shipment or during transportation.

Materials and Finishes

Connectors	Component	Material	Finish	Remarks
Receptacles and Headers	Insulator	LCP	Color : Black	UL94V-0
	Contacts	Phosphor bronze	Gold plated	————
	Metal fittings	Phosphor bronze	Tin-copper plated	————

Ordering information

Receptacles and Headers

DF30 **FC** - ***** **DS - 0.4** **V** **(**)**
 ① ② ③ ④ ⑤ ⑥ ⑦

① Series name: DF30	⑤ Contact pitch: 0.4 mm
② Configuration FB: With metal fittings, without bosses FC: Without metal fittings, without bosses CJ: Connector for conductivity tests	⑥ Termination section V: Straight SMT
③ Number of positions: 20, 22, 24, 30, 34, 40, 50, 60, 70, 80	⑦ Packaging (81): Embossed tape packaging (5,000 pieces per reel) (82): Embossed tape packaging (1,000 pieces per reel)
④ Connector type DS: Double row receptacle DP: Double row header	

■ Receptacles (without metal fittings)

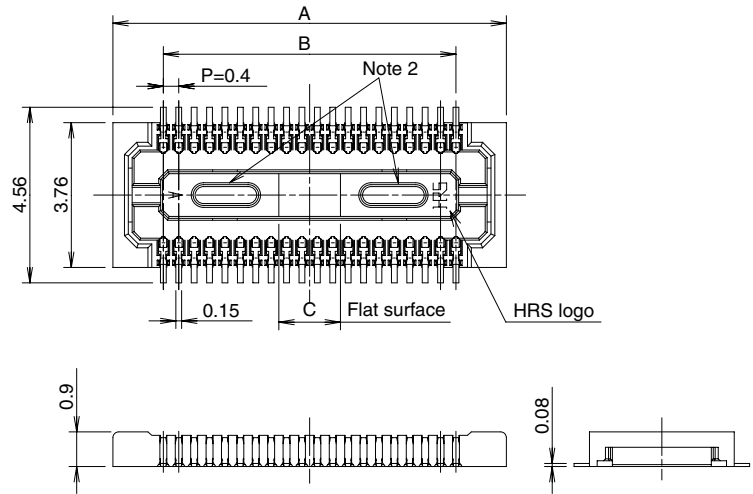
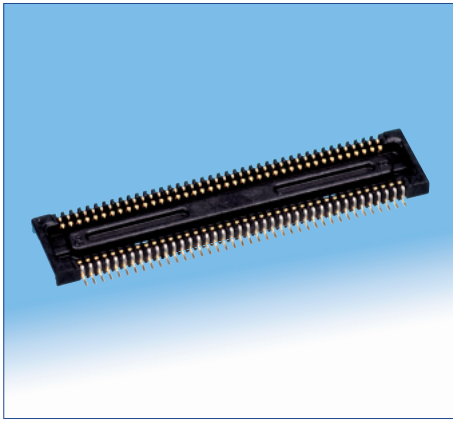

◆ Recommended PCB mounting pattern

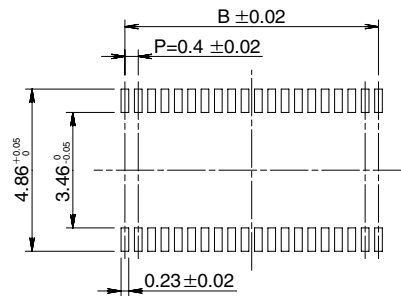

Recommended solder paste thickness: 120 μ m

[Specification number] -**, (**)
(81): Embossed tape packaging (5,000 pieces per reel)

* Tolerances non- accumulative.

Unit: mm

Part Number	CL No.	Number of contacts	A	B	C
DF30FC-20DS-0.4V(**)	CL684-1109-8-**	20	6.22	3.6	1.2
DF30FC-22DS-0.4V(**)	CL684-1110-7-**	22	6.62	4.0	1.2
DF30FC-24DS-0.4V(**)	CL684-1111-0-**	24	7.02	4.4	1.2
DF30FC-30DS-0.4V(**)	CL684-1112-2-**	30	8.22	5.6	1.2
DF30FC-34DS-0.4V(**)	CL684-1113-5-**	34	9.02	6.4	1.36
DF30FC-40DS-0.4V(**)	CL684-1078-6-**	40	10.22	7.6	1.6
DF30FC-50DS-0.4V(**)	CL684-1114-8-**	50	12.22	9.6	2.0
DF30FC-60DS-0.4V(**)	CL684-1082-3-**	60	14.22	11.6	2.4
DF30FC-70DS-0.4V(**)	CL684-1115-0-**	70	16.22	13.6	2.8
DF30FC-80DS-0.4V(**)	CL684-1116-3-**	80	18.22	15.6	3.2

Note 1: Order by number of reels.

Note 2: Receptacles with 24 or fewer contacts positions will not have recessed areas.

Kameraanwendungen



Autopilot



Live-Streaming



Videokonferenz



Biometrische Eye-Tracker-Erkennung

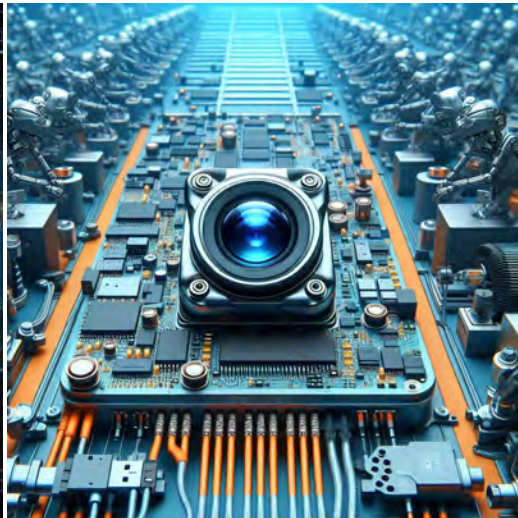

Maschinelles Sehen



Agrarmonitor



Nachtsichtsicherheit



Drohnen- und Sport-Adleraugen



Interaktive Haustierkamera

Referenztable für die Pinbelegungsdefinition des Kameramoduls

OmniVision Sony Himax Samsung On-Semi Aptina Himax GalaxyCore PixArt Bildsensoren	
Pin Signal	Beschreibung
DGND GND	Masse für digitale Schaltung
AGND	Masse für analoge Schaltung
PCLK DCK	DVP-PCLK-Ausgang
XCLR PWDN XSHUTDOWN STANDBY	Abschalten aktiv hoch mit internem Pulldown-Widerstand
MCLK XVCLK XCLK INCK	Systemeingangsuhr
RESET RST	Aktiv Low mit internem Pull-up-Widerstand zurücksetzen
NC NULL	keine Verbindung
SDA SIO_D SIOD	SCCB-Daten
SCL SIO_C SOIC	SCCB-Eingangstakt
VSYNC XVS FSYNC	DVP-VSYNC-Ausgang
HREF XHS	DVP-HREF-Ausgang
DOVDD	Strom für E/A-Schaltung
AFVDD	Strom für VCM-Schaltung
AVDD	Strom für analoge Schaltung
DVDD	Strom für digitale Schaltung
STROBE FSTROBE	Strobe-Ausgang
FSIN	Synchronisieren Sie das VSYNC-Signal vom anderen Sensor
SID	SCCB letzte Bit-ID-Eingabe
ILPWM	mechanische Shutter-Ausgangsanzeige
FREX	Rahmenbelichtung / mechanischer Verschluss
GPIO	Allzweckeingänge
SLASEL	I2C-Slave-Adresse auswählen
AFEN	CEN-Chip aktivieren aktiv hoch auf VCM-Treiber-IC
MIPI Schnittstelle	
MDN0 DN0 MD0N DATA_N DMO1N	MIPI 1st negative Ausgabe der Datenspur
MDP0 DP0 MD0P DATA_P DMO1P	MIPI 1st positiver Ausgang der Datenspur
MDN1 DN1 MD1N DATA2_N DMO2N	MIPI 2nd negative Ausgabe der Datenspur
MDP1 DP1 MD1P DATA2_P DMO2P	MIPI 2nd positiver Ausgang der Datenspur
MDN2 DN2 MD2N DATA3_N DMO3N	MIPI 3rd negative Ausgabe der Datenspur
MDP2 DP2 MD2P DATA3_P DMO3P	MIPI 3rd positiver Ausgang der Datenspur
MDN3 DN3 MD3N DATA4_N DMO4N	MIPI 4th negative Ausgabe der Datenspur
MDP3 DP3 MD3P DATA4_P DMO4P	MIPI 4th positiver Ausgang der Datenspur
MCN CLKN CLK_N DCKN	MIPI Uhr negativer Ausgang
MCP CLKP MCP CLK_P DCKN	MIPI Takt positiver Ausgang
DVP Parallel Schnittstelle	
D0 DO0 Y0	DVP Datenausgabeport 0
D1 DO1 Y1	DVP Datenausgabeport 1
D2 DO2 Y2	DVP Datenausgabeport 2
D3 DO3 Y3	DVP Datenausgabeport 3
D4 DO4 Y4	DVP Datenausgabeport 4
D5 DO5 Y5	DVP Datenausgabeport 5
D6 DO6 Y6	DVP Datenausgabeport 6
D7 DO7 Y7	DVP Datenausgabeport 7
D8 DO8 Y8	DVP Datenausgabeport 8
D9 DO9 Y9	DVP Datenausgabeport 9
D10 DO10 Y10	DVP Datenausgabeport 10
D11 DO11 Y11	DVP Datenausgabeport 11

Kamera-Zuverlässigkeitstest

Zuverlässigkeitsprüfpunkt		Testmethode	Akzeptanzkriterium	
Kategorie	Artikel			
Umwelt	Lager Temperatur	Hoch 60°C 96 Std	Temperaturkammer	Keine anormale Situation
		Niedrig -20°C 96 Std	Temperaturkammer	Keine anormale Situation
	Betriebs Temperatur	Hoch 60°C 24 Std	Temperaturkammer	Keine anormale Situation
		Niedrig -20°C 24 Std	Temperaturkammer	Keine anormale Situation
	Feuchtigkeit	60°C 80% 24 Std	Temperaturkammer	Keine anormale Situation
	Thermischer Schock	Hoch 60°C 0.5 Std Niedrig -20°C 0.5 Std Radfahren rein 24 Std	Temperaturkammer	Keine anormale Situation
Physisch	Falltest (Im freien Fall)	Ohne Verpackung 60cm	10 Mal auf Holzboden	Elektrisch funktionsfähig
		Mit Paket 60cm	10 Mal auf Holzboden	Elektrisch funktionsfähig
	Vibrations Test	50Hz X-Axis 2mm 30 Minuten	Vibrationstisch	Elektrisch funktionsfähig
		50Hz Y-Axis 2mm 30 Minuten	Vibrationstisch	Elektrisch funktionsfähig
		50Hz Z-Axis 2mm 30 Minuten	Vibrationstisch	Elektrisch funktionsfähig
	Zugfestigkeit des Kabels Krafttest	Gewicht laden 4 kg 60 Sekunden Radfahren rein 24 Std	Zugprüfmaschine	Elektrisch funktionsfähig
Elektrisch	ESD-Test	Kontaktaufnahme 2 KV	ESD-Prüfmaschine	Elektrisch funktionsfähig
		Luftentladung 4 KV	ESD-Prüfmaschine	Elektrisch funktionsfähig
	Alterungstest	On/Off 30 Sekunden Radfahren rein 24 Std	Stromschalter	Elektrisch funktionsfähig
	USB-Anschluss	On/Off 250 Mal	Einstecken und ausstecken	Elektrisch funktionsfähig



Kamerainspektionsstandard

Inspektionsgegenstand		Untersuchungsmethode	Inspektionsstandard	
Kategorie	Artikel			
Aussehen	FPC oder PCB	Farbe	Das bloße Auge	Größere Unterschiede sind nicht zulässig.
		Zerrissen/gehackt werden	Das bloße Auge	Das Freilegen von Kupferrissen ist nicht zulässig.
		Markierung	Das bloße Auge	Klar, erkennbar (innerhalb von 30 cm Entfernung)
	Halterin	Kratzer	Das bloße Auge	Die Freilegung von Rissen im Inneren ist nicht zulässig
		Lücke	Das bloße Auge	Erfüllen Sie den Höhenstandard
		Schraube	Das bloße Auge	Stellen Sie sicher, dass Schrauben vorhanden sind (falls vorhanden)
		Schaden	Das bloße Auge	Die Freilegung von Rissen im Inneren ist nicht zulässig
	Linse	Kratzen	Das bloße Auge	Keine Auswirkung auf den Auflösungsstandard
		Kontamination	Das bloße Auge	Keine Auswirkung auf den Auflösungsstandard
		Ölfilm	Das bloße Auge	Keine Auswirkung auf den Auflösungsstandard
		Abdeckband	Das bloße Auge	Kein Problem beim Aussehen.
	Funktion	Bild	Keine Kommunikation	Testboard
Helles Pixel			Tafel	Im Image Center nicht erlaubt
Dunkles Pixel			Weißer Tafel	Im Image Center nicht erlaubt
Verschwommen			Das bloße Auge	Nicht erlaubt
Kein Bild			Das bloße Auge	Nicht erlaubt
Vertikale Linie			Das bloße Auge	Nicht erlaubt
Horizontale Linie			Das bloße Auge	Nicht erlaubt
Kleines Leck			Das bloße Auge	Nicht erlaubt
Blinkendes Bild			Das bloße Auge	Nicht erlaubt
Prellung			Inspektionslehre	Nicht erlaubt
Auflösung			Diagramm	Folgt dem Diagrammstandard für ausgehende Inspektionen
Farbe			Das bloße Auge	Kein Problem
Lärm			Das bloße Auge	Nicht erlaubt
Ecke dunkel			Das bloße Auge	Weniger als 100 x 100 Pixel
Farbauflösung			Das bloße Auge	Kein Problem
Abmessungen	Höhe	Das bloße Auge	Befolgt Zulassungsdatenblatt	
	Breite	Das bloße Auge	Befolgt Zulassungsdatenblatt	
	Länge	Das bloße Auge	Befolgt Zulassungsdatenblatt	
	Gesamt	Das bloße Auge	Befolgt Zulassungsdatenblatt	

YDSCAM Paketlösungen

YDSCAM Kameramodul



Komplett mit Linsenschutzfolie



Tablett mit Gitter und Raum



Legen Sie die Kameras auf das Tablett



YDSCAM Paketlösungen

Volles Fach mit Kameras

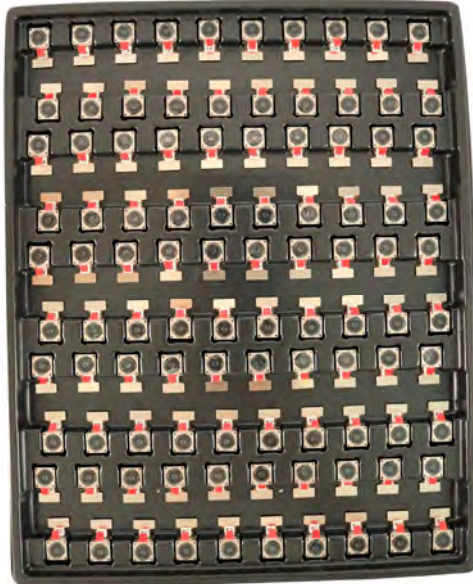

Decken Sie das Tablett mit dem Deckel ab

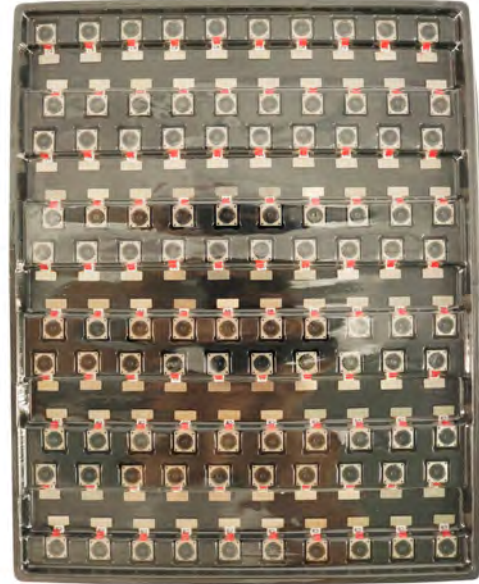

Legen Sie das Tablett in den antistatischen Beutel



Staubsaugen Sie den antistatischen Beutel



YDSCAM Paketlösungen

Versiegelter antistatischer Vakuumbbeutel mit Etiketten

1. Modell und Beschreibung 2. Menge 3. Herstellungsdatumscode 4. Achtung



YDSCAM Paketlösungen

Legen Sie Schaumstoffplatten zwischen die Tablettbeutel



Schaumstoffplatten sind größer als Tablett



Legen Sie Schaumstoffplatten und Tablett in den Karton



Die Schaumstoffplatten sitzen fest im Karton



Verschließen Sie die Carbon Box



Beschriften Sie den Carbon-Versandkarton



YDSCAM Paketlösungen

USB-Kameramodul

Komplett mit Objektivschutzfolie

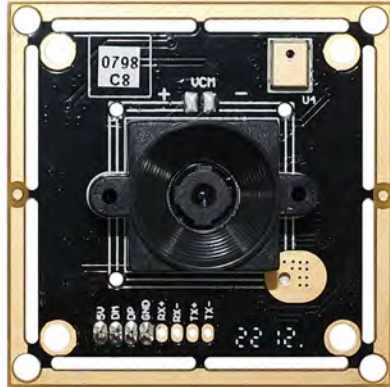

Legen Sie die Kameraprobe in den antistatischen Beutel

Legen Sie USB-Kameras in das Fach



Verschließen Sie das Tablett mit einem antistatischen Beutel

Beschriften Sie den Carbon-Versandkarton



YDSCAM Paketlösungen

Legen Sie die Kameraprobe in den antistatischen Beutel



Legen Sie die Steckverbinder in den antistatischen Beutel



Beschriften Sie die Probenbeutel



Stecken Sie die Steckverbinder in die Spule



Legen Sie Proben in die Carbonbox



Stecken Sie die Steckverbinder in die Carbonbox





Firma YDSCAM

YingDeShun Co. Ltd. (YDS) wurde 2017 gegründet, ein technologieorientierter Hersteller der nächsten Generation, der sich auf Forschung, Design und Produktion von Audio- und Videoprodukten spezialisiert hat. YDS verfügt über 20.000 Quadratmeter große automatisierte Anlagen mit 100 Mitarbeitern und einem Jahresdurchsatz von 30.000.000 Kameraeinheiten.

YDS bietet OEM- und ODM-Design sowie Auftragsfertigung und baut die Kameraprodukte. Sie können uns die Anforderungen mitteilen, sogar mit einem Handentwurf. Unser Vertrieb und unsere Technik arbeiten zusammen, um Ihre Anforderungen zu erfüllen. Wir verstehen uns als Ihr langfristiger Partner bei der Entwicklung praktischer und innovativer Lösungen.

Unser Team deckt alles von der ersten Konzeptentwicklung bis zum Massenprodukt ab. YDS ist auf kundenspezifisches Kameradesign, Rohmaterial, Elektroniktechnik, Firmware-/Softwareentwicklung, Produkttests und Verpackungsdesign spezialisiert. Unsere erfahrenen strategischen Liefersysteme bieten eine robuste und zuverlässige Fertigungskapazität für Aufträge unterschiedlicher Größe.

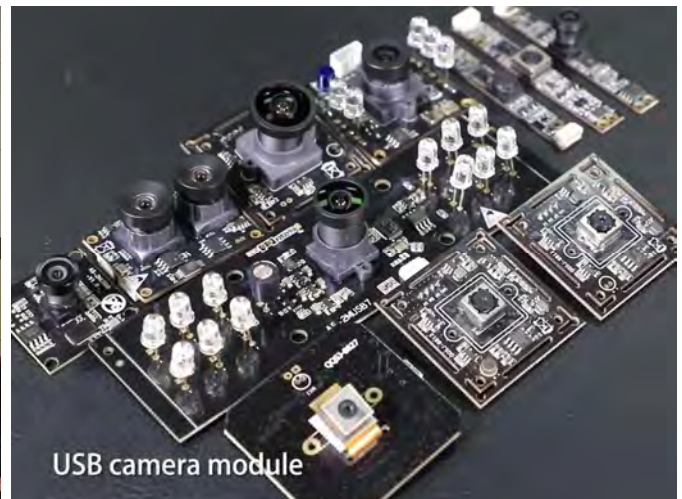

Eingeschränkte Garantie

YDS gewährt die folgende eingeschränkte Garantie, wenn Sie das/die Produkt(e) direkt von der YDS-Firma oder über die YDS-Website www.YDSCAM.com erworben haben. Von anderen Verkäufern oder Quellen gekaufte Produkte fallen nicht unter diese eingeschränkte Garantie. YDS garantiert, dass die Produkte bei normalem Gebrauch für einen Zeitraum von einem (1) Jahr ab dem Datum, an dem Sie das Produkt erhalten („Garanzzeitraum“), frei von Material- und Verarbeitungsfehlern sind.

Für alle Produkte, die während der Garanzzeit wesentliche Material- oder Verarbeitungsfehler aufweisen oder entwickeln, wird YDS nach eigenem Ermessen entweder: (i) das/die Produkt(e) reparieren; (ii) das/die Produkt(e) durch ein/e neue oder generalüberholte(n) Produkt(e) ersetzen (wobei das/die Ersatzprodukt(e) vom identischen Modell oder einer gleichwertigen Funktion sein müssen); oder (iii) Ihnen eine Rückerstattung des Preises gewähren, den Sie für das/die Produkt(e) bezahlt haben.

Diese eingeschränkte Garantie von YDS beschränkt sich ausschließlich auf Reparatur und/oder Ersatz gemäß den oben dargelegten Bedingungen. YDS ist nicht zuverlässig oder verantwortlich für etwaige Folgeereignisse.





YDS CAMERA MODULE

your best camera partner

Unsere Unternehmensstärke

Leistungsstarke Fabrik



Professioneller Service



Versprochene Lieferung



www.YDSCAM.com sales@ydscam.com Phone (WeChat, QQ): (+86) 177 2732 6718

All rights reserved @ YingDeShun Co. Ltd. Specifications subject to change without notice.